

# TSI VEDA - 230VAC

## User Manual V7.1

### BEYOND THE INVERTER

THE NEW GENERATION OF POWER CONVERTERS

- » **SINGLE INPUT INVERTER**  
The DC Power as default source
- » **AC BACKUP IN A DC ENVIRONMENT**  
Leverage your existing DC infrastructure
- » **ONE STOP SHOP**  
wide output power range



# Table of content

1. Abbreviations.....	4
2. Safety instructions .....	5
2.1 Handling.....	6
2.2 Other.....	6
3. TSI TECHNOLOGY.....	7
3.1 REG-mode.....	7
4. Building blocks .....	8
4.1 Inverter.....	8
4.2 Sub-rack .....	8
4.3 Monitor unit T1S/T2S.....	9
5. Accessories .....	10
5.1 Cabinet.....	10
5.2 AC distribution unit.....	10
5.2.1 Distribution Rack .....	10
6. Monitoring accessories .....	11
6.1 Can Dis shelf .....	11
6.1.1 Display .....	11
6.1.2 TCP/IP Agent.....	11
7. System Design.....	12
7.1 Pack / A la Carte .....	12
7.1.1 Pack .....	12
7.1.2 A la Carte.....	12
8. Installation of Veda PACK or Single shelf/shelves.....	13
8.2 Electrical installation (Veda PACK or single shelf) .....	13
8.2.1 Pre requisites.....	14
8.2.2 Terminations.....	15
8.2.3 Grounding.....	15
8.2.4 DC input .....	15
8.2.5 AC output.....	16
8.2.6 Signalling.....	16
8.2.7 Remote ON/OFF .....	17
8.2.8 Internal bus (TSI Bus 6 pin / TSI Bus 8 pin).....	18
9. Installation of cabinet (A la Carte).....	19
9.1 Unpacking the system .....	19
9.2 Raising the cabinet.....	19
9.3 Fixing the cabinet to the floor.....	19
9.4 Electrical installation.....	19
9.4.1 Positioning.....	20
9.4.2 Cabling .....	20
9.4.3 Grounding.....	21
9.4.4 DC input (X1) .....	21

9.4.5	Connection Table DC Input -48VDC (X1) .....	23
9.4.6	Signalling.....	24
10.	Interface .....	26
10.1	Inverter module .....	26
10.2	T1S .....	27
10.2.1	T1S alarm.....	27
10.3	T2S .....	27
11.	System set up.....	28
11.1	Communication setting.....	28
11.2	Menu access .....	29
12.	Inserting/removing/replacing modules .....	30
12.1	TSI Inverter .....	30
12.1.1	Removal .....	30
12.1.2	Inserting .....	30
12.2	T1S/T2S .....	31
12.2.1	Removal .....	31
12.2.2	Inserting .....	31
12.3	Fan replacement.....	31
13.	AC output distribution .....	32
13.1	DU connection installation/removal.....	32
13.2	Miniature Circuit breaker installation/removal .....	32
14.	Finishing.....	33
15.	Commissioning .....	34
15.1	Check list .....	35
16.	Trouble shooting .....	36
17.	Maintenance.....	37
17.1	Access T2S with lap top.....	37
17.2	Manual check.....	37
17.3	Optional.....	37
18.	Defective modules .....	38
19.	Appendix .....	39
19.1	Cabinet foot print, layout.....	39
19.2	Single phase circuit diagram .....	40

## 1. Abbreviations

---

TSI	Twin Sine Innovation
EPC	Enhanced Power Conversion
REG	Regular
DSP	Digital Signal Processor
AC	Alternating current
DC	Direct current
ESD	Electro Static Discharge
MET	Main Earth Terminal
MBP	Manual By-pass
TCP/IP	Transmission Control Protocol/Internet Protocol
USB	Universal Serial Bus

## 2. Safety instructions

---

- The modular inverter system/rack can reach hazardous leakage currents. Earthing must be carried out prior energizing the system. Earthing shall be made according to local regulations.
- Prior any work conducted to a system/unit make sure that DC input voltage is disconnected.
- Inverter modules and shelves comprise capacitors for filtering and energy storage. Prior to accessing to the system/modules wait min 5 minutes to allow capacitors to discharge.
- AC and DC circuits shall be terminated with no voltage / power applied.
- Some components and terminals carry high voltage during operation. Contact may result in fatal injury.
- Warning labels must not be removed.
- Never wear metallic objects such as rings, watches, bracelets during installation, service and maintenance of the product.
- Insulated tools must be used at all times when working with live systems.
- When handling the system/units pay attention to sharp edges.
- ESD Strap must be worn when handling PCBs and open units.
- The modular inverter system/rack is not supplied with internal disconnect devices on input nor output.
- The modular inverter rack is a single input power supply. The complete system shall be wired in a way that both input and output leads can be made powerless in a single action.
- REG systems can be seen as independent power sources. To comply with local and international safety standards N (output) and PE shall be bonded.
- The safety standard IEC/EN62040-1-1 requires that, in case of output short circuit, the inverter must disconnect in maximum 5 seconds. Parameter can be adjusted on T2S; however, if the parameter is set at a value > 5 seconds, an external protection must be provided in order that the short circuit protection operates within 5 seconds. Default setting is 60s.
- The equipment must be installed and commissioned by skilled technicians according to instructions in this manual.
- Local regulations must be adhered.
- The manufacturer declines all responsibilities if equipment is not- installed according to -instructions herein -by skilled technician -according to local safety regulation.
- Warranty does not apply if the product is not installed, used and handled according to the instructions in the manuals.
- CE+T cannot be held responsible for disposal of the Inverter system and therefore the customer must segregate and dispose the materials which are potentially harmful to the environment, in accordance with the local regulations in force in the country of installation.
- If the equipment is dismantled, to dispose of the products it consists of, you must stick to the local regulations in force in the country of destination and in any case avoid causing any kind of pollution.

## 2.1 Handling

- The cabinet shall not be lifted using lifting eyes.
- Remove weight from the cabinet by unplugging the inverters. Mark inverters clearly with shelf and position for correct.
- Empty inverter positions must not be left open. Replace with module or cover.

## 2.2 Other

- Isolation test must not be performed without instructions from the manufacturer.

## 3. TSI TECHNOLOGY

Inverter modules carrying the TSI logo and the REG mark is a traditional converter (DC in, AC out). Sinusoidal output converted from DC input.

Typical loads

- Resistive load
- Inductive and resistive
- Capacitive and resistive
- Non linear (electronic)

### 3.1 REG-mode

Inverter modules carrying the TSI logo and the REG mark is a traditional converter (DC in, AC out). Sinusoidal output converted from DC input.

- DC input only.
- The output voltage is always conditioned, low THD (sinusoidal output)
- The overload capacity is 135% for 15 seconds
- The inverter efficiency is >88%.

The TSI works according to True Redundant Structure (TRS) that features decentralized logic, redundant communication bus and three levels of, individually independent, disconnection.

Isolation test must not be performed without instructions from the manufacturer.

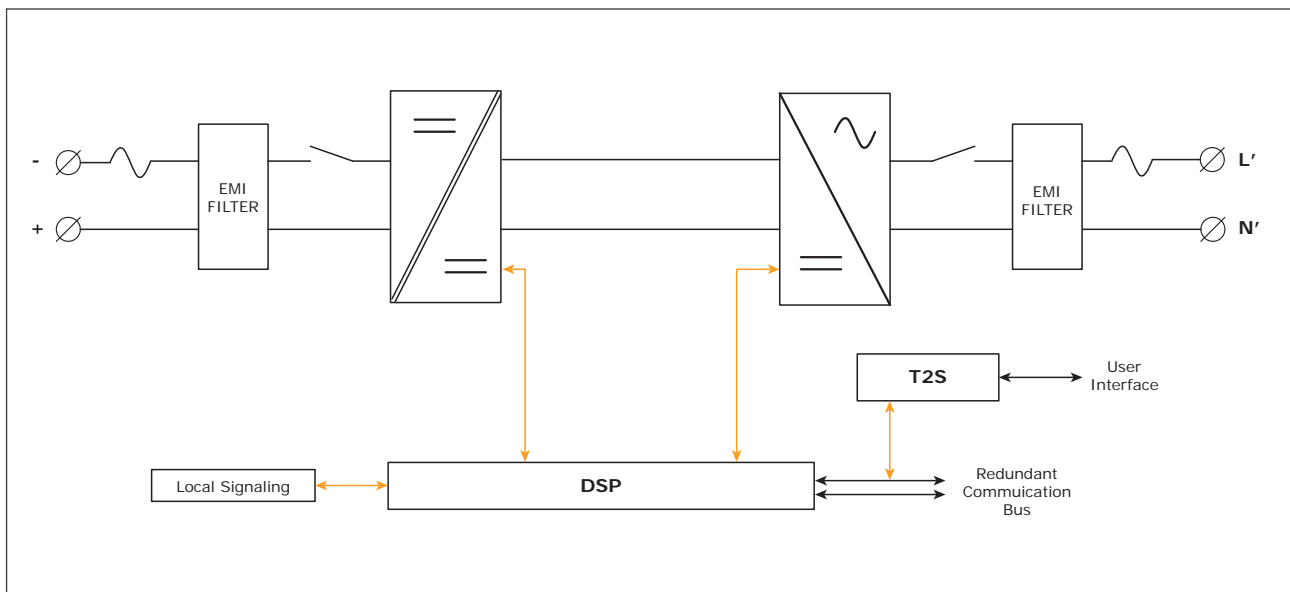

## 4. Building blocks

### 4.1 Inverter

Telecom / Datacom: -48VDC / 230VAC, 50/60Hz



- The TSI Veda is a 600VA/480W (-25 upto +50 deg C), above +50 degree C ,power derated to 500VA/400W(upto +65 deg C) dual port inverter.
- All versions available in REG.
- The TSI inverter modules are hot swappable and hot pluggable.
- The module operator interface is LEDs showing converter status and output power
- Inverter modules run in single phase configurations.
- Fan is equipped with alarm and run time meter. The fan is field replaceable.
- 220 (D) x 139 (W) x 41.5 (H)
- 1.4 Kg

### 4.2 Sub-rack

- The Veda shelf shall be integrated in min 300mm deep cabinets (recommended 400-600mm),Inch/ETSI mounting.
- The Veda shelf house three (3) modules or two (2) inverter modules + one (1) AC output unit and one (1) monitor unit.
- The extension shelf house max three (3) inverter modules and one (1) monitor blank.
- The Veda shelf is designed with individual DC input and Common AC output.
- Max 1.5kVA per shelf
- 267 (D) x 19" (W) x 1U (H)
- 2.1 Kg empty





## 4.3 Monitor unit T1S/T2S

The T1S is the default monitor unit and T2S is the optional monitor unit for Veda pack  
T2S is the default monitor unit for A la Carte; monitors max 32 inverters in one bus

The T1S provides

- Alarm monitoring
- 2 outgoing alarms
- 2 digital input
- Dip switch for local setting

The T2S provides

- Alarm monitoring
- Record the latest 200 events. Fi-Fo
- 3 outgoing alarms
- 2 digital input
- MOD bus (Default)
- CAN bus (Optional)
- USB front connector for local setting

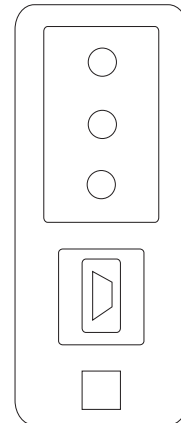
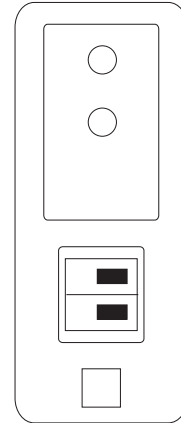

## 5. Accessories

### 5.1 Cabinet

Powder coated (RAL 7035), 19 “welded steel sheet cabinet with 600x600mm foot print. Cabinet designed for top cabling or bottom cabling.

- 1100mm (600x600mm) 21U
- 1800mm (600x600mm) 37U
- 2110mm (600x600mm) 44U

The cabinet comes with a separable top cover to facilitate cabling. Tie strap support at cable entrance/exit.

Door optional accessory

Veda is suitable for easy integration in 300, 400, 600 mm depth cabinet.

### 5.2 AC distribution unit

#### 5.2.1 Distribution Rack

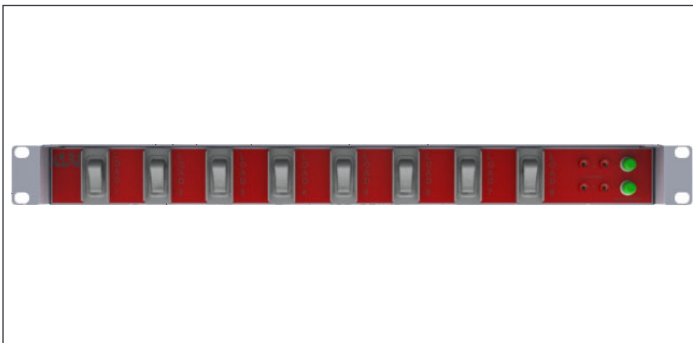

The standard AC output distribution is designed with a 8X 6A breaker with Lamp indication and Voltage test point

Max current per AC DU is 20A, max current per output connector is 6A ,applicable only upto 4.5KVA A la Carte system/pack.

Alarm for AC output breakers is present (OF or SD). The alarm function is common and use one of the digital input on the control unit.

## 6. Monitoring accessories

### 6.1 Can Dis shelf

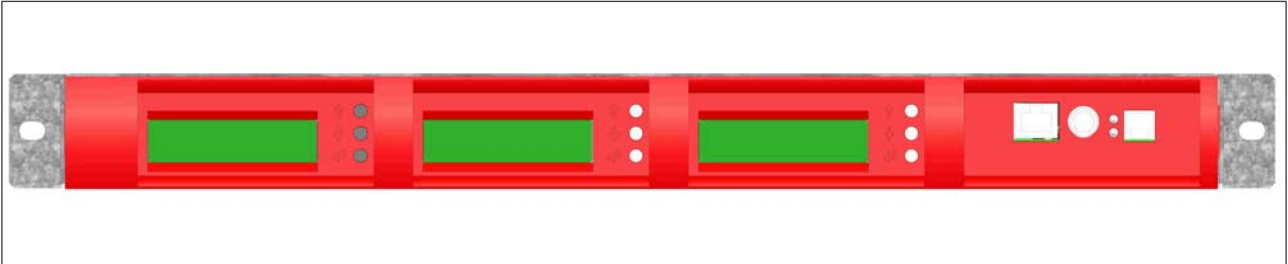

The CanDis shelf has room for 1-3 display units and 1 TCP/IP agent.

#### 6.1.1 Display

Backlit 2 line dot matrix

The display show two values simultaneous

#### 6.1.2 TCP/IP Agent

The TCP/IP interface board is mounted on the CanDis shelf and is powered within the system.

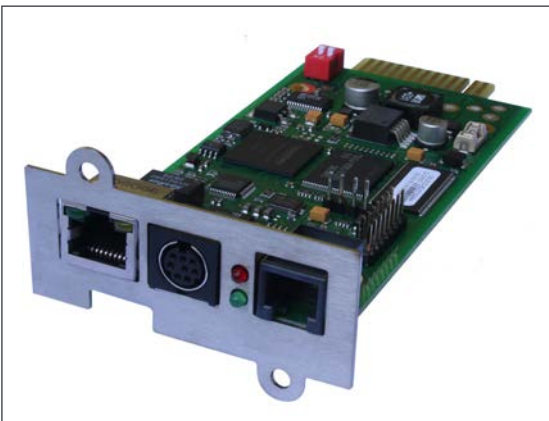

## 7. System Design



### 7.1 Pack / A la Carte

The systems designed are divided in two topologies.

#### 7.1.1 Pack

The PACK is a pre assembled and configured single phase inverter system comprising 19" inverter sub rack, inverter modules, monitor device and AC output distribution breaker. The PACK is normally mounted in a 19" rack. Mounting kit is included in the delivery. The PACK is only available as single phase, -48VDC, REG-mode. A PACK comprises of max 5 inverter modules.

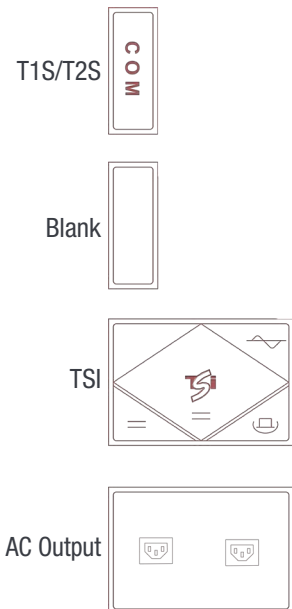
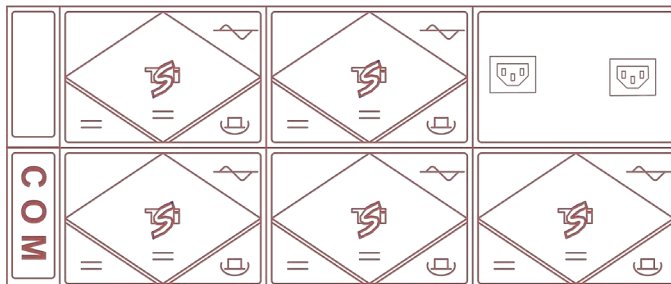

#### 7.1.2 A la Carte

The A la Carte is pre assembled and configured as single phase systems. The system comprises cabinet, inverter sub rack, inverter modules, monitor device(T2S) and AC output distribution.

The A la Carte is available as only REG (Regular) operation.  
The A la Carte (single phase) populate 1 to 24 modules, max 14.4KVA

- Single input (DC) inverter modules (REG)
- 89% efficiency at REG mode
- Always conditioned and filtered output voltage
- No single point of failure
- Flexible AC output distribution
- T2S MOD bus default, T2S CAN bus optional
- Full modularity
- Full redundancy

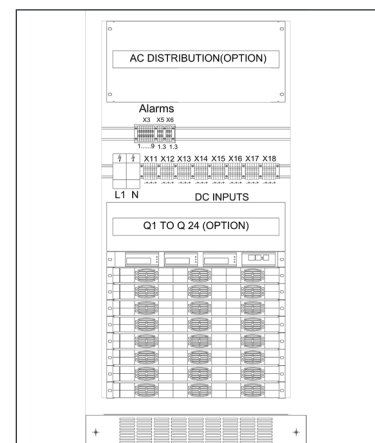

## 8. Installation of Veda PACK or Single shelf/shelves

- Read safety instructions prior starting any work
- Do NOT attempt to use lifting eyes to erect the cabinet.
- System is preferable handled without modules.
- Pay attention to the module position, make sure that modules are repositioned in the same slot.
- T1S/T2S is always mounted in the first shelf, left hand position.
- In PACK the 3rd inverter position (1st sub-rack) comprise an output distribution 2 x IEC socket with 10 Amps fuse protection.

### 8.1 Mounting kit (Veda PACK or Single shelf)

The mounting guide rail is adjustable to fit different kind of cabinet depths.

### 8.2 Electrical installation (Veda PACK or single shelf)

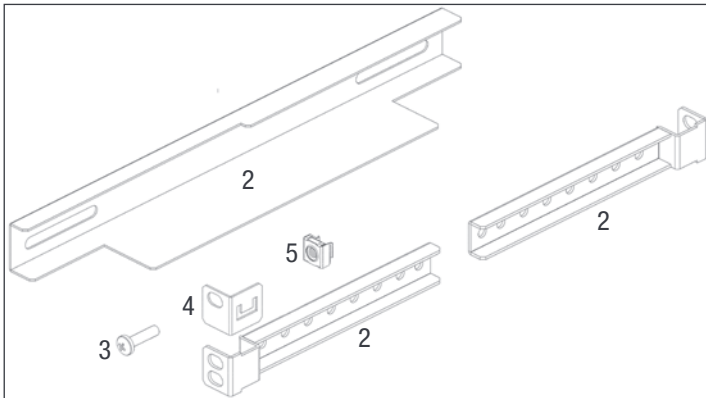

- 4x Fixing brackets (ref 1)
- 2x Slider (ref 2)
- 2x Mounting brackets (ref 3)
- 12x Mounting screws (ref 4)
- 12x Cage nuts (ref 5)

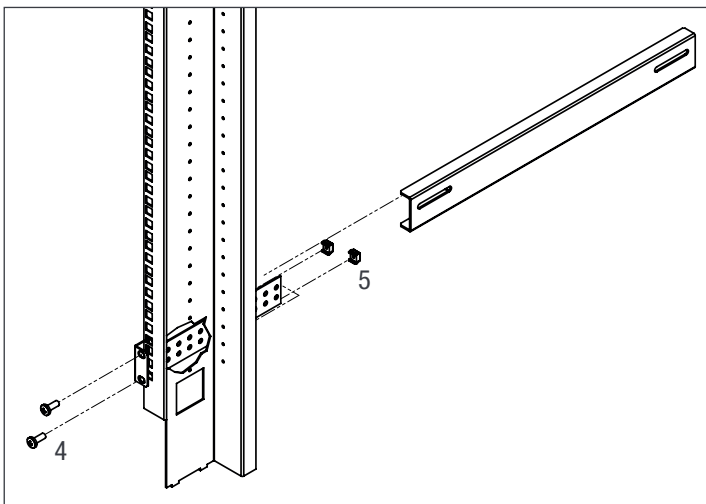

- Assemble the sliders and adjust the length to suit the mounting depth
- Fix cage nuts (5) in the cabinet front and rear frame of the left and the right side
- Fix the left and right slider of the cabinet with the supplied screws (4)

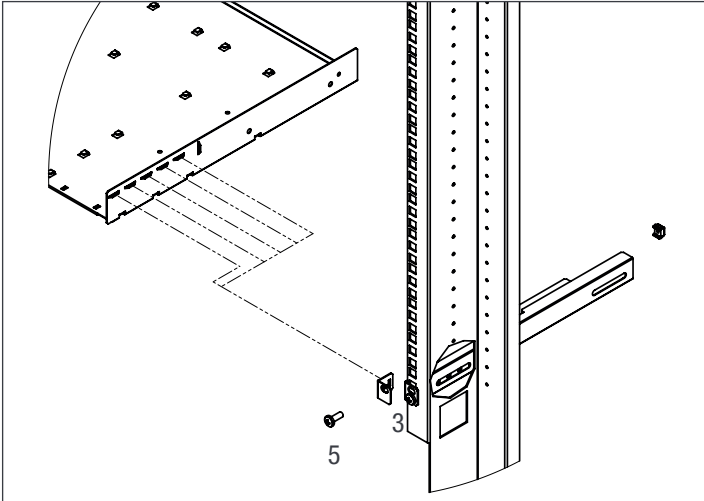

Fix cage nuts (4) in the mounting frame

Assemble the mounting bracket (3) in a suitable position.

Slide the shelf in position and fix the shelf with the supplied screws (5)

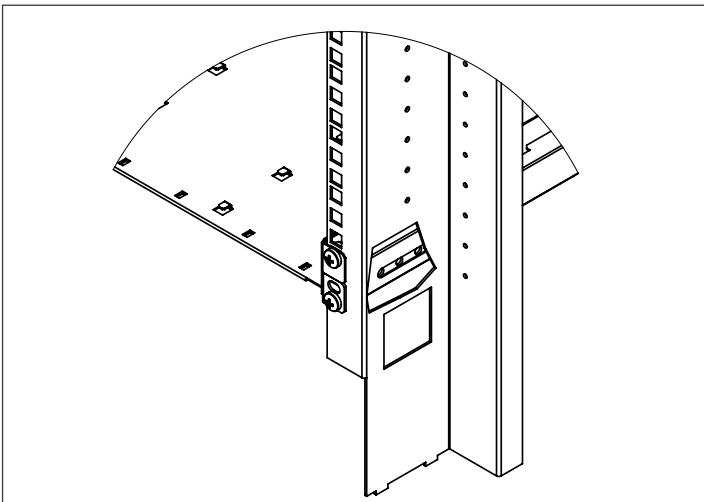

Finished

## 8.2.1 Pre requisites

- The sub –rack have markings for all terminations
- All cables shall be rated at Min 90 deg C.
- Electrical terminations shall be tightened with 1,5Nm
- All connection are screw terminals connectors
- DC Input-Individual (per module), observe polarity.
- AC output –Common (per shelf), respect phases.
- Wire all positions in the sub-rack for future expansion
- Output AC / Input DC / Signal cables shall be separated
- Cable crossings shall be done in 90 deg angles

## 8.2.2 Terminations

All terminations are clearly marked.

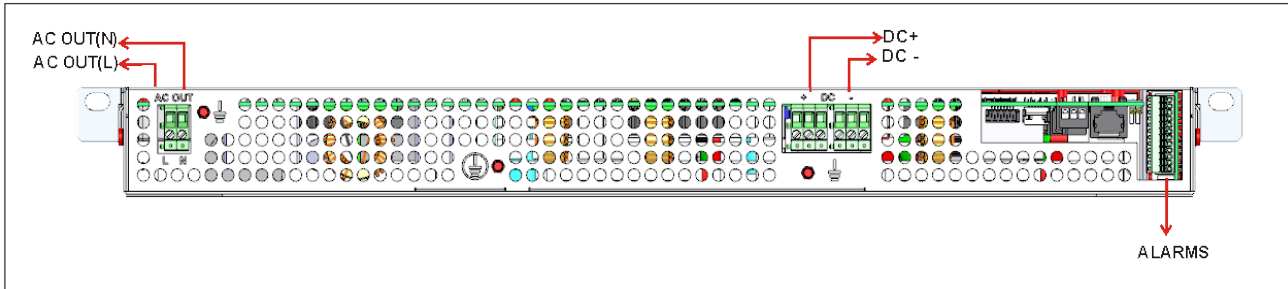

## 8.2.3 Grounding

“PE CHASSIS GROUND”

PE Chassis ground shall be wired to MET or distributed earth bar connected to MET

According to local regulations.

## 8.2.4 DC input

	CB per module	Cable, min	Connector	Torque
-48VDC Veda pack	16A	2 x 1.5mm <sup>2</sup>	Screw terminal	1.5Nm

VEDA is individual DC feeding. On the back the terminal of (+) and (-) are present. DC connector are wired as a couple. That means that the first right (-) terminal and the first (+) terminal correspond to the left inverter on the front. Same thing for center (-) terminal and the center (+) terminal correspond to the center inverter on the front, etc.

## 8.2.5 AC output

	Cable, min	Connector	Torque
Veda pack Single shelf	3x1.5mm <sup>2</sup>	2 IEC Socket protected by 10 Amps fues	-
Veda pack Double shelf	3x2.5mm <sup>2</sup>	2 IEC Socket protected by 10 Amps fues	-
-48VDC	3x1.5mm <sup>2</sup>	Screw Terminal	1.5Nm

## 8.2.6 Signalling

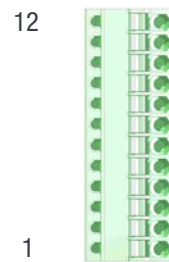
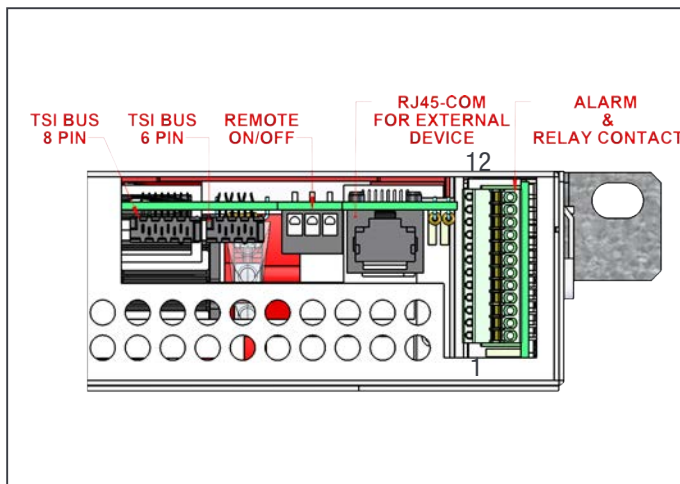

### Relay characteristics (Selectable, Major, Minor)

- Switching power 60W
- Rating 2A at 30VDC / 1A at 60VDC
- Max wire size 1mm<sup>2</sup>

### Digital input characteristics (Digital In 1 / 2)

- Signal voltage +5VDC (galvanic insulated)
- Max wire size 1mm<sup>2</sup>

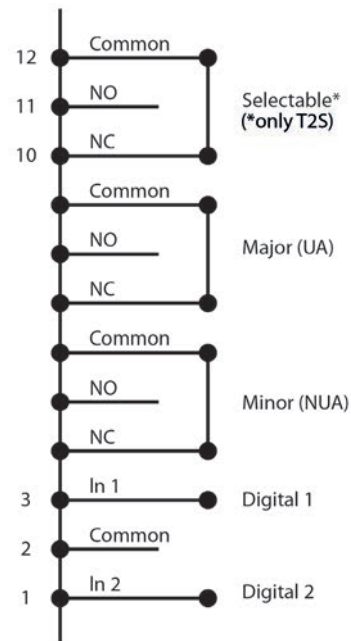



## 8.2.7 Remote ON/OFF

Notice: The shelf is by default equipped with a connection between pin 3 and 2. If remote ON/OFF is not used the strap shall remain in all connected shelves. Should the remote ON/OFF be used all straps must be removed and in one (1) shelf replaced with a changeover contact or emergency button.

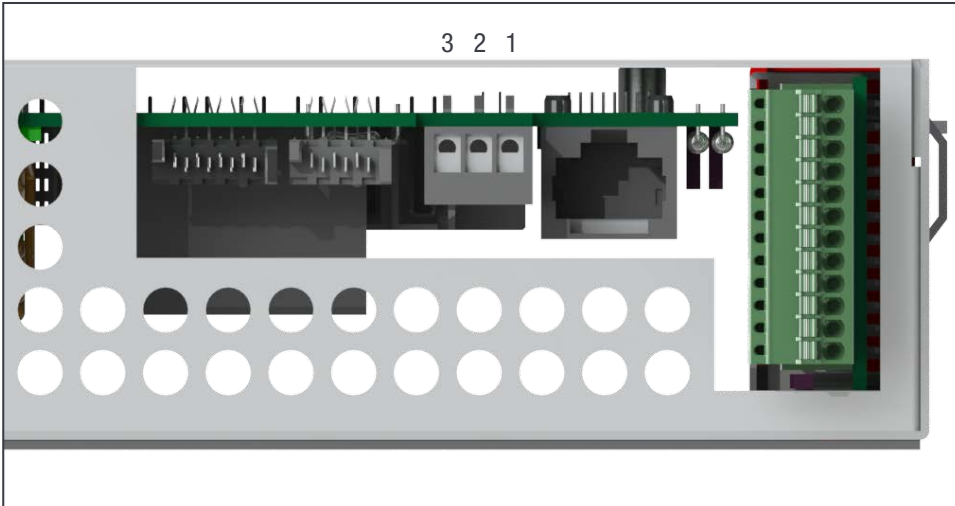

- The remote ON/OFF switch the output AC OFF.
- input DC is not affected by the remote ON/OFF.
- The remote ON/OFF can be connected to any shelf.
- The remote ON/OFF requires changeover contacts, one input opens as the other close. If both transitions are not picked up the status is not changed

### Relay characteristics (Remote ON/OFF)

- Signal voltage +5VDC (galvanic insulated)
- Max wire size 1mm<sup>2</sup>

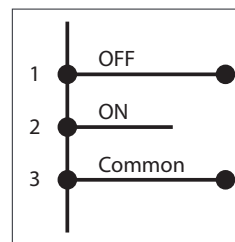

### Functional table for remote ON/OFF function

#	Pin 1-3	Pin 2-3	Status	Indication
1	Open	Open	Normal operation	All (Green)
2	Closed	Open	OFF	AC output (OFF) DC Input (Green)
3	Open	Closed	Normal operation	All (Green)
4	Closed	Closed	Normal operation	All (Green)

### 8.2.8 Internal bus (TSI Bus 6 pin / TSI Bus 8 pin)

- In PACK/A la Carte systems the internal Bus is pre installed
- The internal bus comprise of a 6 pole ribbon cable and an 8 pole ribbon cable.
- The internal bus connectors are sensitive and special caution should be taken during installation to keep them out of harms way
- The internal bus is connected from the first shelf to the last shelf.

## 9. Installation of cabinet (A la Carte)

### 9.1 Unpacking the system

The cabinet is packed in a wooden box.

The packing material of the TSI system is recyclable.

Transport the cabinet in the box on the pallet.

### 9.2 Raising the cabinet

The top cover fixing bolts must NOT be replaced with lifting eye bolts. Mark and remove modules from the cabinet, that the modules can be replaced in the same slot, and raise the cabinet on location.

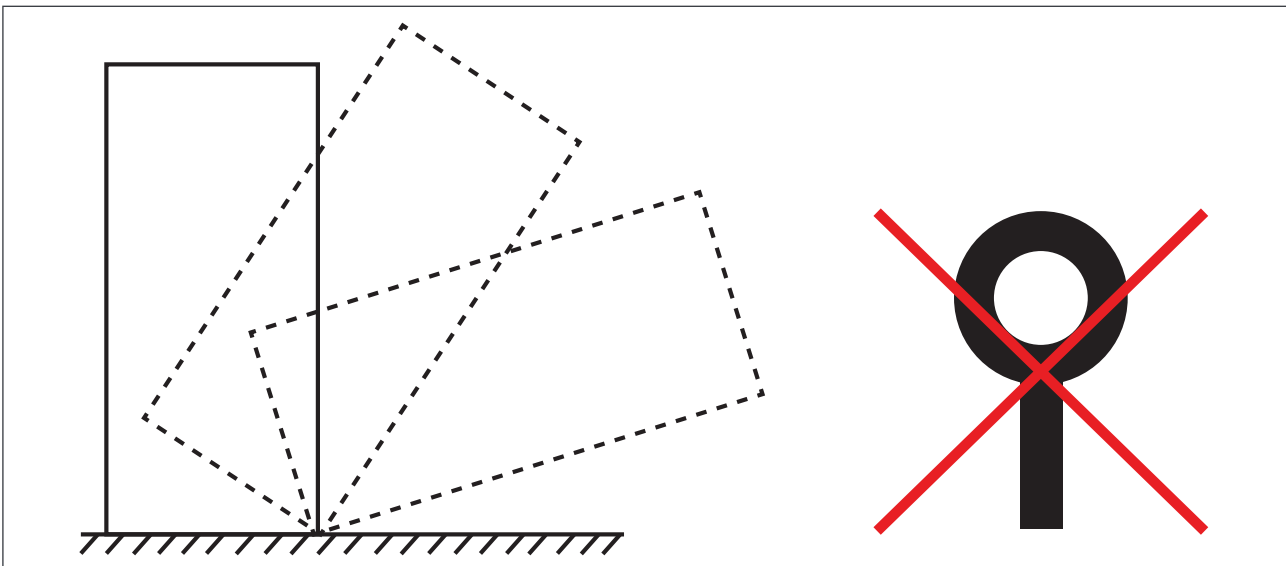

### 9.3 Fixing the cabinet to the floor

The cabinet is fixed through the base of the cabinet.

Remove lowest front cover to gain access to the fixing holes.

Max screw diameter is 22mm. See Hole pattern, foot print. for foot print measurements.

### 9.4 Electrical installation

- All cables shall be halogen free and rated min 90 deg C.
- Wire all positions for future expansion
- Output AC / Input DC / Signal cables shall be separated
- Cable crossings shall be done in 90 deg angles
- Empty inverter positions shall be covered with blanks

## 9.4.1 Positioning

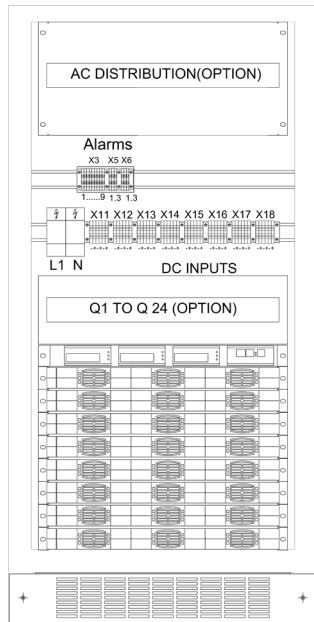

AC Output distribution (X4)

DC Input (X11 to X18) Alarm (X3) / Digital in (X5), Remote ON/OFF (X6), Bulk AC output (X4)

Internal DC distribution (Q1-Q6)  
CanDis shelf (Option)

Phase 1  
Inverter sub rack  
Inverter modules

**PLEASE ! Refer to the technical drawings received with your cabinet for exact positioning!**

## 9.4.2 Cabling

Note: Do not block the airflow through the top of the cabinet.  
Cables are run through the top of the cabinet or the bottom.  
The top cover is possible to split in three parts to facilitate cabling.

The top cover has support to strap the cables with nylon tie straps.

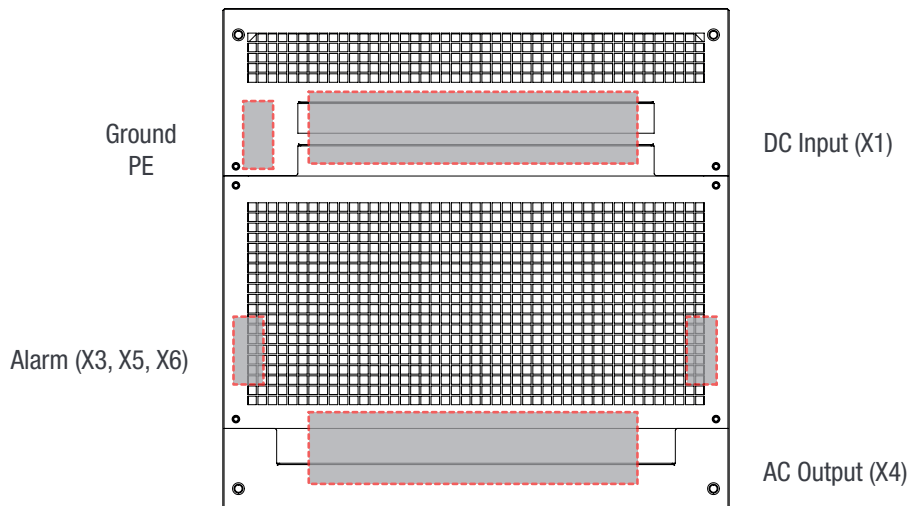

## 9.4.3 Grounding

Ground terminal are located in the top rear left corner.

“PE CHASSIS GROUND”

PE Chassis ground shall be wired to MET or distributed earth bar (MET). Ground must be terminated even if commercial mains is not available.

According to local regulations, Min 16mm<sup>2</sup>.

## 9.4.4 DC input (X1)

### 9.4.4.1 Bulk input

- Common DC input per system.
- Note: Screws and nuts are not included in the delivery.
- M12 holes
- Internal DC distribution with circuit breakers (Q01-Q24) per inverter module.
- Max 1x240mm<sup>2</sup> per pole

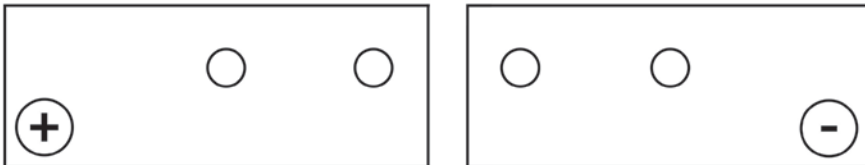

#### 9.4.4.2 Individual input

- Individual DC input per module and return.
- Max 2.5 mm<sup>2</sup> per connection terminal. (Two terminal for one shelf)

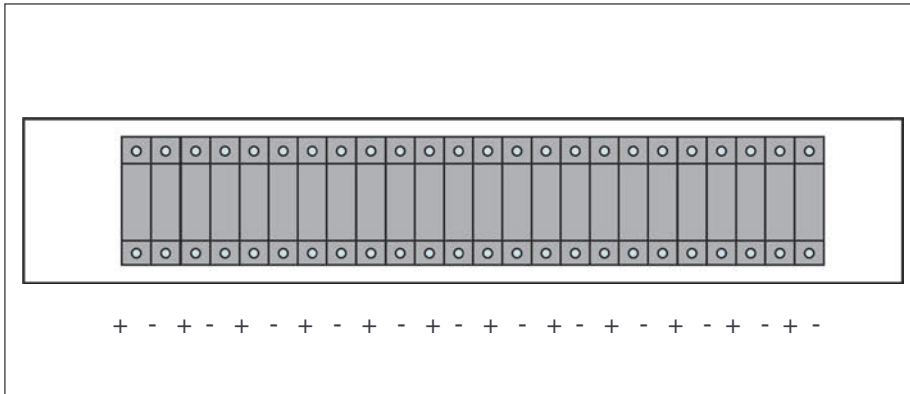

9.4.5 Connection Table DC Input -48VDC (X1)

Power (kVA)	DC Input Bulk		DC Input individual	
	Cable lug		Screw terminal/cable lug	
1ph	Fuse/CB	Min. Cable mm <sup>2</sup>	Fuse/CB	Min Cable mm <sup>2</sup>
1.8	50A	10		
3.6	100A	25	16A	Live: Screw terminal 1.5mm <sup>2</sup>  Common: Ferrule. 1.5 mm <sup>2</sup> -1,5Nm torque
5.4	160A	50		
7.2	180A	70		
9	250A	120		
10.8	300A	150		
12.6	315A	185		
14.4	400A	240		

## 9.4.6 Signalling

All relays are in non energized position

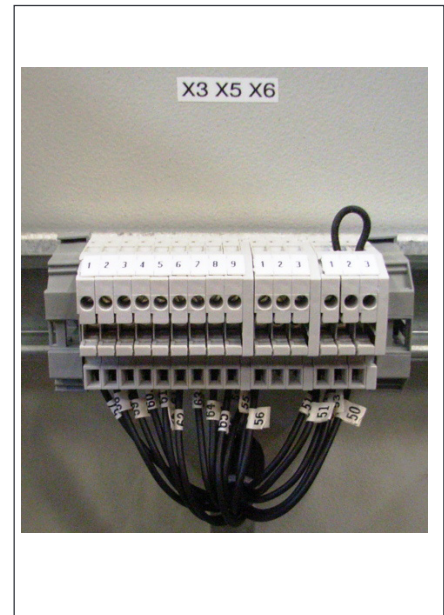
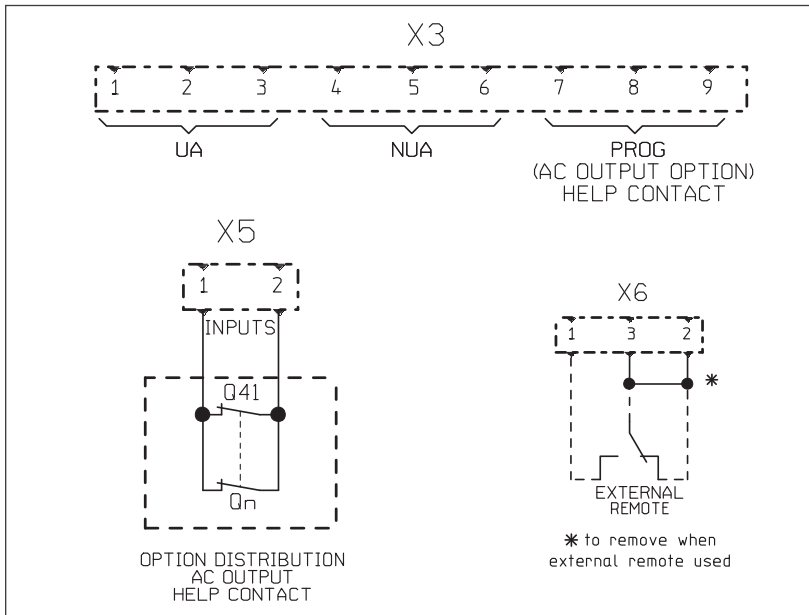



### 9.4.6.1 Alarm (X3)

- Relay characteristics X3 (Major (UA), Minor(NUA), Prog)

- Switching power 60W
- Rating 2A at 30VDC / 1A at 60VDC
- Max wire size 1mm<sup>2</sup>

### 9.4.6.2 Digital In (X5)

- Input characteristics X5 (Digital In 1, Digital In 2)

- Signal voltage +5VDC (galvanic insulated)
- Max wire size 1mm<sup>2</sup>

### 9.4.6.3 Remote ON/OFF (X6)

Note: The system is by default equipped with a connection between pin 3 and 2. If remote ON/OFF is not used the strap shall remain. Should the remote ON/OFF be used the strap must be replaced with a changeover contact or emergency button.

- The remote ON/OFF switch the output AC OFF.
- Input AC and input DC is not affected by the remote ON/OFF.
- The remote ON/OFF can be connected to any shelf.
- The remote ON/OFF requires changeover contacts, one input opens as the other close. If both transitions are not picked up the status is not changed.
- Digital input characteristics (Remote On/Off)
  - Signal voltage +5VDC (galvanic insulated)
  - Max wire size 1mm<sup>2</sup>

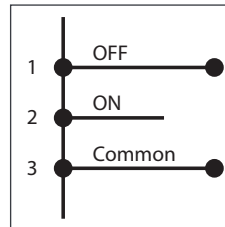

Functional table for remote ON/OFF function

#	Pin 1-3	Pin 2-3	Status	Indication
1	Open	Open	Normal operation	All (Green)
2	Closed	Open	OFF	AC output (OFF) AC Input (Green) DC Input (Green)
3	Open	Closed	Normal operation	All (Green)
4	Closed	Closed	Normal operation	All (Green)

### 9.4.6.4 Forced start

Initial start of system must be performed with operational T2S. Should the T2S be missing at start-up the modules will fail to start.

The following sequence of the Remote ON/OFF will force system to start without the T2S

#3 ==> #2 ==> #3 will force modules to start.

## 10.Interface

### 10.1 Inverter module

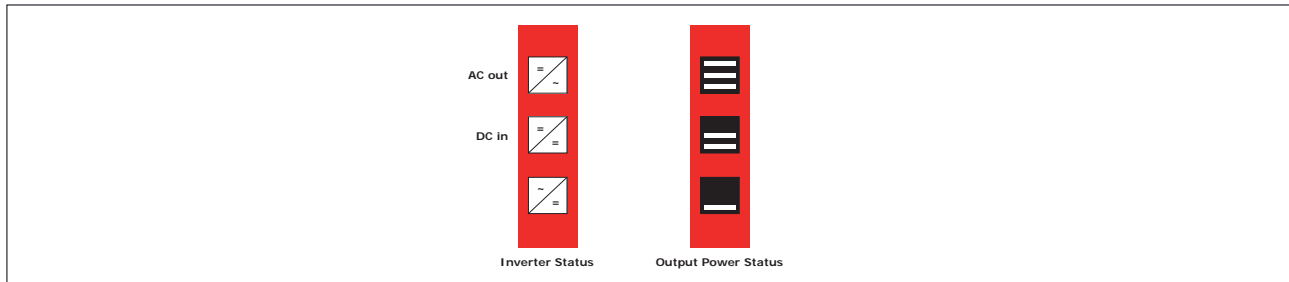

Inverter Status LED	Description	Remedial action
OFF	No input power or forced stop	Check environment
Permanent green	Operation	
Blinking green	Converter OK but working conditions are not fulfilled to operate properly	
Blinking green/orange alternatively	Recovery mode after boost (10 In short circuit condition)	
Permanent orange	Starting mode	
Blinking orange	Modules cannot start	Check T2S
Blinking red	Recoverable fault	
Permanent red	Non recoverable fault	Send module back for repair

Output Power (redundancy not counted)						
<5%	5% to 40%	40 to 70%	80 to 95%	100%	100% = overload	Output Power (redundancy not counted)
×	×	×	≡	≡	≡	Status output power LED
×	×	≡	≡	≡	≡	
—	—	—	×	—	—	
1B	1P	2P	2P	3P	3B	Behavior (B = blinking – P permanent )

## 10.2 T1S

- Alarm indication on T1S (Urgent / Non Urgent / Configurable)
  - Green: No alarm
  - Red: Alarm
- Outgoing alarm relay delay
  - Urgent 60 seconds delay
  - Non urgent 30 second delay
- Parameter setting with DIP1 and DIP2.
- If inverters are removed for shorter or longer time the T1S must be reset to display valid alarms, unplug T1s and reinsert for a reset.
- Parameter set up (other than factory default) requires the use of T2S as an installation tool, see System set up
- In three phase applications replacement and extension inverter modules must be configured T2S

Major Alarm

Minor Alarm

DIP Switch 1

DIP Switch 2

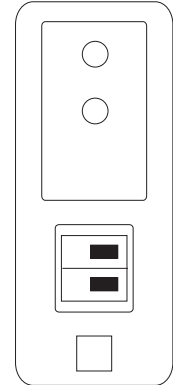

	Category	Left position	Right position
DIP 1	Digital in detection	Open for active	Close for active
DIP 2	Redundancy	No Redundancy	Redundancy

### 10.2.1 T1S alarm

	Description	Type
1	Redundancy plus one inverter lost by	Major
2	TSI Bus defect	Major
3	Incompatibility parameter	Major
4	Main source lost (see configuration done by T2S)	Major
5	At least one digital input activated (*2)	Major
6	Redundancy lost	Minor
7	Secondary source lost	Minor
8	At least one invert in alarm	Minor

## 10.3 T2S

- Alarm indication on T2S (Urgent / Non Urgent / Configurable)
  - Green: No alarm
  - Red: Alarm
  - Flashing Exchanging information with inverters (only Configurable alarm)
- Outgoing alarm relay delay
  - Urgent 60 seconds delay
  - Non urgent 30 second delay
- Parameter setting via Laptop or Copy/Paste.
- Factory default according to list of set values, see Table of set values

Major Alarm

Minor Alarm

User selectable Alarm

USB port

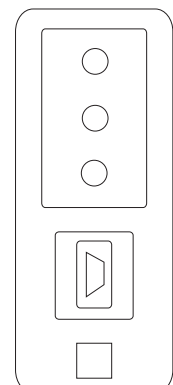

## 11. System set up

- Parameter set up requires Hyper terminal installed on laptop
- USB cable type A to B (not included)
- T2S driver "CET\_T2S.inf" installed on laptop.
- Available for download at <http://www.acbackuptsi.com>
  - Username: T322010000
  - Password: No password required (enter)
- Read T2S manual for detailed setup

### 11.1 Communication setting

- Bits per second      115200
- Data bits              8
- Parity                  None
- Stop bits               1
- Flow control           None

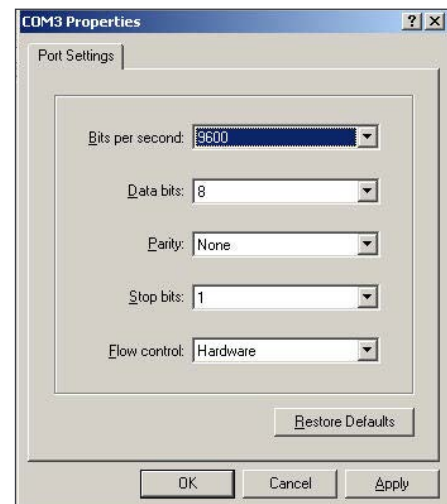

## 11.2 Menu access

### Root Menu

- 1 > System configuration
  - 0 > Return to previous menu
  - 1 > Send config file to T2S
  - 2 > Read config file from T2S
  - 3 > Restore default settings (no more available since version 2.5)
  - 4 > Restore factory settings (no more available since version 2.5)
- 2 > System information's selection
  - 0 > Return to previous menu
  - 1 > Module information's
    - 0 > Return to previous menu
    - 1 > Variables set 1
    - 2 > Variables set 2
    - 3 > Variables set 3
    - 4 > Variables set 4
    - + > Next page
    - > Previous page
  - 2 > Phase information
    - 0 > Return to previous menu
    - 1 > Variables set 1
    - 2 > Variables set 2
    - 3 > Variables set 3
  - 3 > Groups information
    - 0 > Return to previous menu
    - 1 > Display AC group information
    - 2 > Display DC group information
  - 4 > Alarms information
    - 0 > Return to previous menu
    - 1-1 > Page selection
  - 5 > History of the log display
    - 0 > Return to previous menu
    - 1-14 > Page number selection
    - 16 > Clear log
    - 17 > Save log to a file
  - 6 > Module errors information
    - 0 > Return to preceding menu
    - 1-32 > detailed Modules errors
- 3 > System actions selection
  - 0 > Return to previous menu
  - 1 > System actions
    - 0 > Return to index
    - 1 > Turn ON system
    - 2 > Turn OFF system
    - 3 > Change Date and time setting
  - 2 > Inverter Module action
    - 0 > Return to previous menu
    - 1-4 > Page number selection
    - 5 > Identify selected Module
    - 6 > Turn ON selected Module
    - 7 > Turn OFF selected Module
    - 8 > Change address of sel. Module
    - 9 > Change phase of selected Module
    - 10 > Automatic address assignment
    - 11 > Change DC group of selected Module
    - 12 > Change AC group of sel. Module
    - 13 > Notify changed fan of sel. Module
    - + > Increment selector
    - > Decrement selector
  - 3 > T2s actions
    - 0 > Return to index
    - 1 > Force refresh of configuration textes and constants
    - 2 > Force refresh of events description texts
- 4 > Security Access
  - 0 > Return to index
  - 1 > Enable Password protection

## 12. Inserting/removing/replacing modules

### 12.1 TSI Inverter

- The TSI inverter is hot swappable.
- When a new module is inserted in a live system it automatically adapt to working set of parameters.
- When a new module is inserted in a live system it automatically assigns the next available address.

#### 12.1.1 Removal

Notice: When one or several inverter modules is/are removed it gains access to live parts. Replace module with blinds without delay.

- Inverter module is not switched off when opening the handle. The handle only fixes the module to the shelf.
- Use a screw driver to release the latch of the handle
- Open the handle
- Pull the module out
- Replace with new module or blind unit

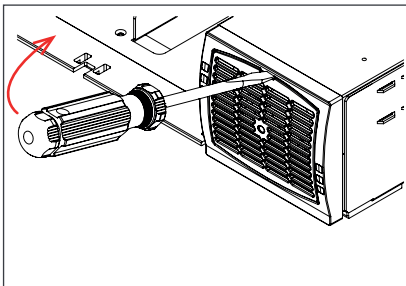

A) Use screwdriver to release the latch

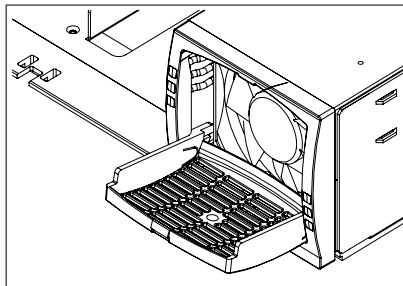

B) open the cover completely

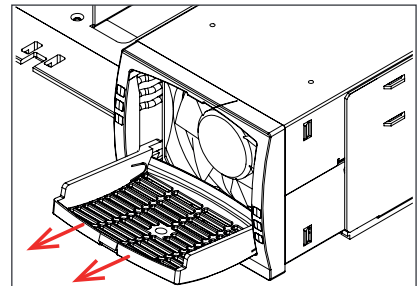

C) Use the cover as a handle to remove the module

#### 12.1.2 Inserting

- Use a screw driver to release the latch of the handle
- Open the handle
- Push firmly until the unit is properly connected.
- Close the cover and latch in position

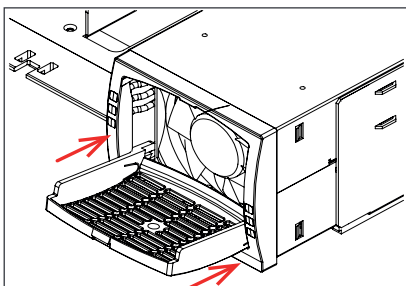

A) Slide the module in

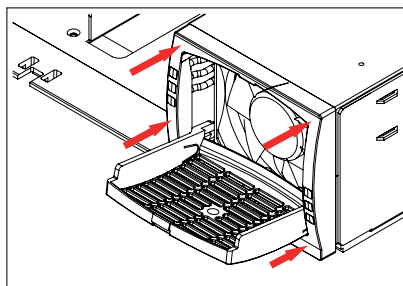

B) Push firmly till the connection is properly engaged

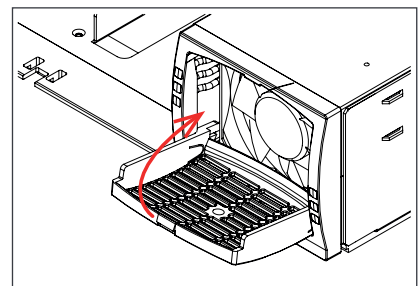

C) Close the cover and latch the module in place if too hard redo step B

## 12.2 T1S/T2S

### 12.2.1 Removal

- Use a small screw driver to release the latch keeping the T1S/T2S in position
- Take care when inserting screw driver in T1S. If tip is not well engaged, there is a chance to damage dip switches
- Pull the module out

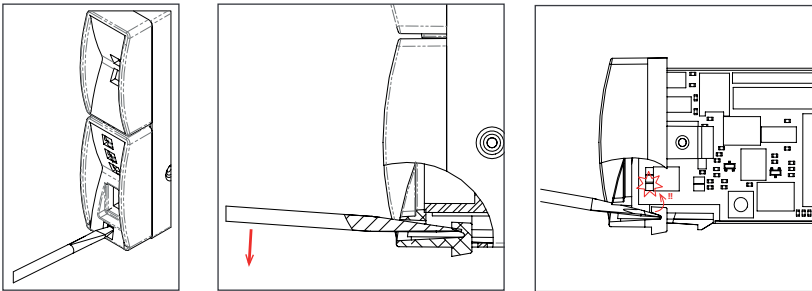

### 12.2.2 Inserting

- Push the module firmly in place until the latch snaps in position

## 12.3 Fan replacement

The FAN life is approx 45.000hours. The inverter modules have fan runtime meters and fan failure alarm. Fan failure can result from failing fan or driver circuit.

- Let the module rest at least 5 minutes prior to initiating work.
- The inverter front must be removed. Use a blunt tool to depress the latches on the module side fixing the front to the module.
- Remove the fan and unplug the supply cord.
- Replace with new fan and connect supply cord
- Replace front, make sure that the front latch properly.
- Plug in
- Check fan for operation
- Access T2S and reset the fan run time alarm from within the action menu

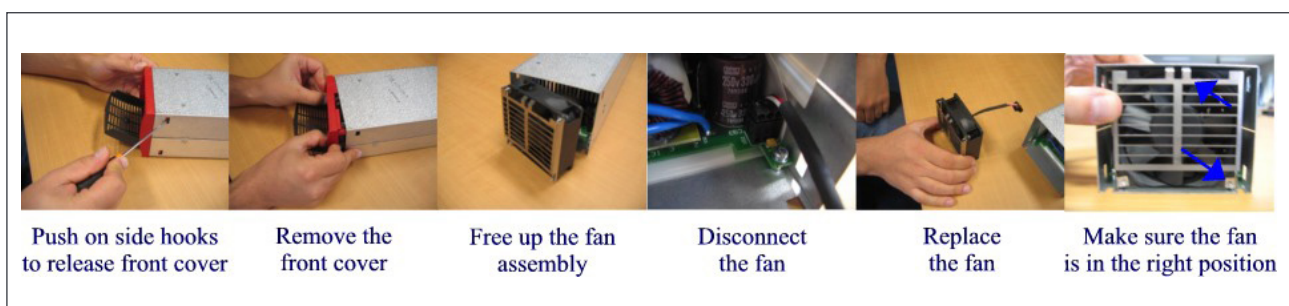



## 13.AC output distribution

### 13.1 DU connection installation/removal

Output connection is provided with 8 IEC connector which is connected to each 6A rated breaker

IEC connector can be plugged in for the output connection of load cable

unplugged for removing output connection

Switch breaker ON

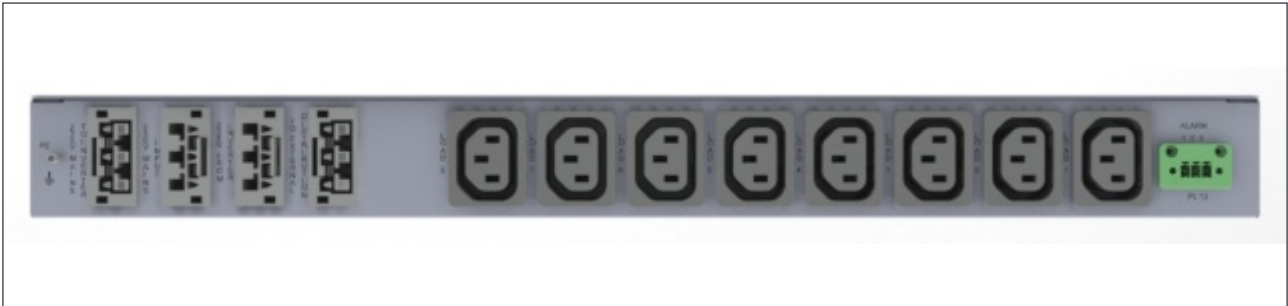

### 13.2 Miniature Circuit breaker installation/removal

Circuit breakers are normally installed from factory.

How to add breakers

1. Insert the short connection cable (10mm<sup>2</sup> (included)) in the breaker Line-side and tighten.
  - Up to 40A breaker use one connection cable.
  - 63A breaker use two connection cables.
2. Clip breaker on to the DIN rail
3. Insert Insulated screw driver in the terminal to load the spring
4. Insert connection cable and remove screw driver
5. Connect load cable to breaker, Neutral and Ground
6. Switch breaker ON
7. Remove breaker in reverse order

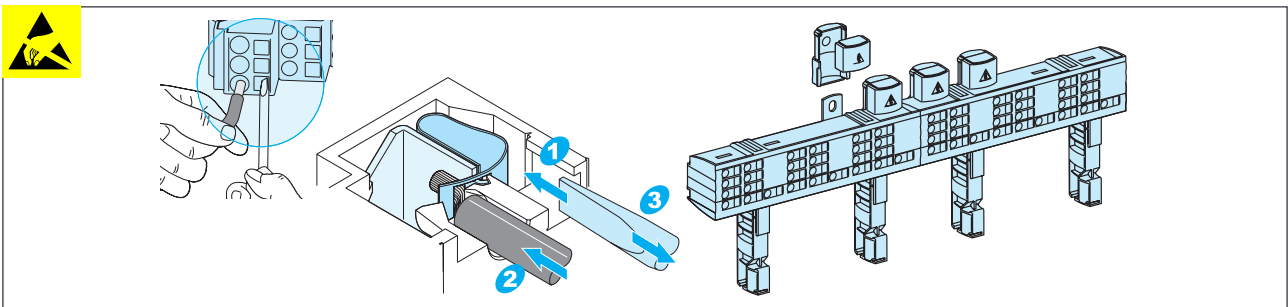



## 14. Finishing

---

- Make sure that the sub-rack/cabinet is properly fixed to the cabinet/floor
- Make sure that the sub-rack/cabinet is connected to Ground.
- Make sure that all DC and breakers are switched OFF.
- Make sure that all cables are according to recommendations and local regulations.
- Make sure that all cables are strained relieved.
- Make sure that all breakers are according to recommendation and local regulations.
- Make sure that DC polarity is according to marking.
- Re tighten all electrical terminations.
- Make sure that no inverter/controller positions are left open.
- Cover empty inverter positions with blanks.
- Make sure that the Remote ON/OFF is appropriately wired according to local regulations.
- Make sure that the point of AC supply meets local regulations.

## 15. Commissioning

---

The DC breaker is a protection device. When modules are plugged in a system please make sure the corresponding DC breaker is engaged in the ON position. Failure to observe this rules will result not to have all module operating when running on DC.

Installation and commissioning must be done and conducted by trained people fully authorized to act on installation.

It is prohibited to perform any isolation test without instruction from manufacturer.

Equipments are not cover by warranty if procedures are not respected.

## 15.1 Check list

DATA	
Date	
Performed by	
Site	
System serial number	
Module serial numbers	
T1S/T2S serial number-Specify T1S/T2S	
ACTION	
	OK/ N.OK
Unplug all inverters except one inverter per phase (Just pull off the inverter from the shelf, to interrupt electrical contacts)	
Check the commercial AC before closing the AC input breaker. (Not applicable for REG Module)	
Switch ON the commercial AC (Not applicable for REG Module)	
Check if inverters are working (Green led) (Not applicable for REG Module)	
Check the DC power supply and switch ON the DC breakers	
Plug in all inverters one by one	
Check output voltage (on bulk output or on breaker)	
Check if inverters are working properly	
Check if system has no alarm (Disable the alarm if any)	
Read configuration file and review all parameters. Some parameters must be adapted according to the site (LVD, load on AC, AC threshold level)	
Switch OFF ACin and check if system is working on DC (Not applicable for REG Module)	
Switch ON ACin and check if system correctly transferred load on AC (Not applicable for REG Module)	
Switch OFF system and start on AC only (Not applicable for REG Module)	
Switch OFF system and start on DC only	
Check if display working properly (if this CANDIS option is present)	
Check if TCPIP working properly (if this option is present)	
Test on load (if available)	
ALARM	
Switch ON DC input and check that no alarm are present	
Pull out one inverter and check alarm according to redundancy	
Pull out two inverters and check alarm according to redundancy	
Switch OFF AC input (commercial power failure) and check the alarm according to the configuration (Not applicable for REG Module)	
Switch OFF DC input (DC power failure) and check that the alarm according to the configuration	
Check the different digital input according to the configuration (when used)	

## 16. Trouble shooting

---

Inverter does not power up:	<ul style="list-style-type: none"><li>Check that the inverter is properly inserted</li><li>Reposition inverter to verify that slot is not damaged</li><li>Check DC input present and in range (DC breakers)</li><li>Check for loose terminations</li></ul>
Inverter does not start:	<ul style="list-style-type: none"><li>Check that T2S is present and properly inserted</li><li>Check remote ON/OFF terminal</li><li>Check the configuration and setting</li><li>Check threshold level</li></ul>
No output power:	<ul style="list-style-type: none"><li>Check output breaker</li></ul>
All OK but I have alarm:	<ul style="list-style-type: none"><li>Check configuration file and correct No of modules</li><li>Download/clear log file</li></ul>
No output alarm:	<ul style="list-style-type: none"><li>Mind the default time delay (UA: 60s, NUA: 30s)</li><li>Check configuration file</li></ul>
No information on CanDis:	<ul style="list-style-type: none"><li>Check that T2S is present and properly inserted</li><li>Check that the RJ45 cable is connected between T2S shelf and CanDis shelf</li></ul>
No value on TCP/IP:	<ul style="list-style-type: none"><li>Check that the RJ45 cable is connected between T2S shelf and CanDis shelf</li><li>Wait approx 2 minutes to allow the system to collect serial data.</li></ul>

## 17. Maintenance

---

Maintenance shall only be performed by properly trained people.

### 17.1 Access T2S with lap top

- Download system LOG FILE and save
  - Analyze log file and correct errors
- Download system CONFIGURATION FILE and save
  - Check/correct configuration file according to operation conditions
  - Check/correct alarm configuration
- Check module internal temperature for deviation between modules
  - Temperature deviation may indicate build up of dust. Clean with compressed air
- Check module/system load
- Check/Correct inverter mapping (DC group/AC group/ Address)
- Check outgoing alarm, consult configuration file what actions will generate alarm

### 17.2 Manual check

- Validate input voltage (DC input, AC output) with multi-meter
- Replace dust filter
- Take a snap shot of the cabinet

### 17.3 Optional

- With an infrared camera check termination hot spots
  - Tighten terminations

## 18. Defective modules

<b>TSI-EPC</b> 48V-230VAC-MEDIA	
P/N: T331730201 S/N: 030669	
<b>INPUT:</b> Vdc in : 48 V (40-58) Idc in : 30A --- Vac in : 230 V (185-265) 50/60Hz Iac in: 6A	
<b>OUTPUT:</b> Vac out : 230 V 50/60Hz Iac out : 6.5A Power: 1200W/1500VA	
<b>CE</b>	
<b>BURN IN</b>	<b>STAMP</b>
41/10	
MADE IN BELGIUM	

- A repair request should follow the regular logistics chain:  
End-user => Distributor => CE+T Power.
- Before returning a defective product, a RMA number must be requested through the <http://my.cet-power.com> extranet. Repair registering guidelines may be requested by email at [repair@cet-power.com](mailto:repair@cet-power.com).
- The RMA number should be mentioned on all shipping documents related to the repair.
- Be aware that products shipped back to CE+T Power without being registered first will not be treated with high priority!

## 19.Appendix

### 19.1 Cabinet foot print, layout

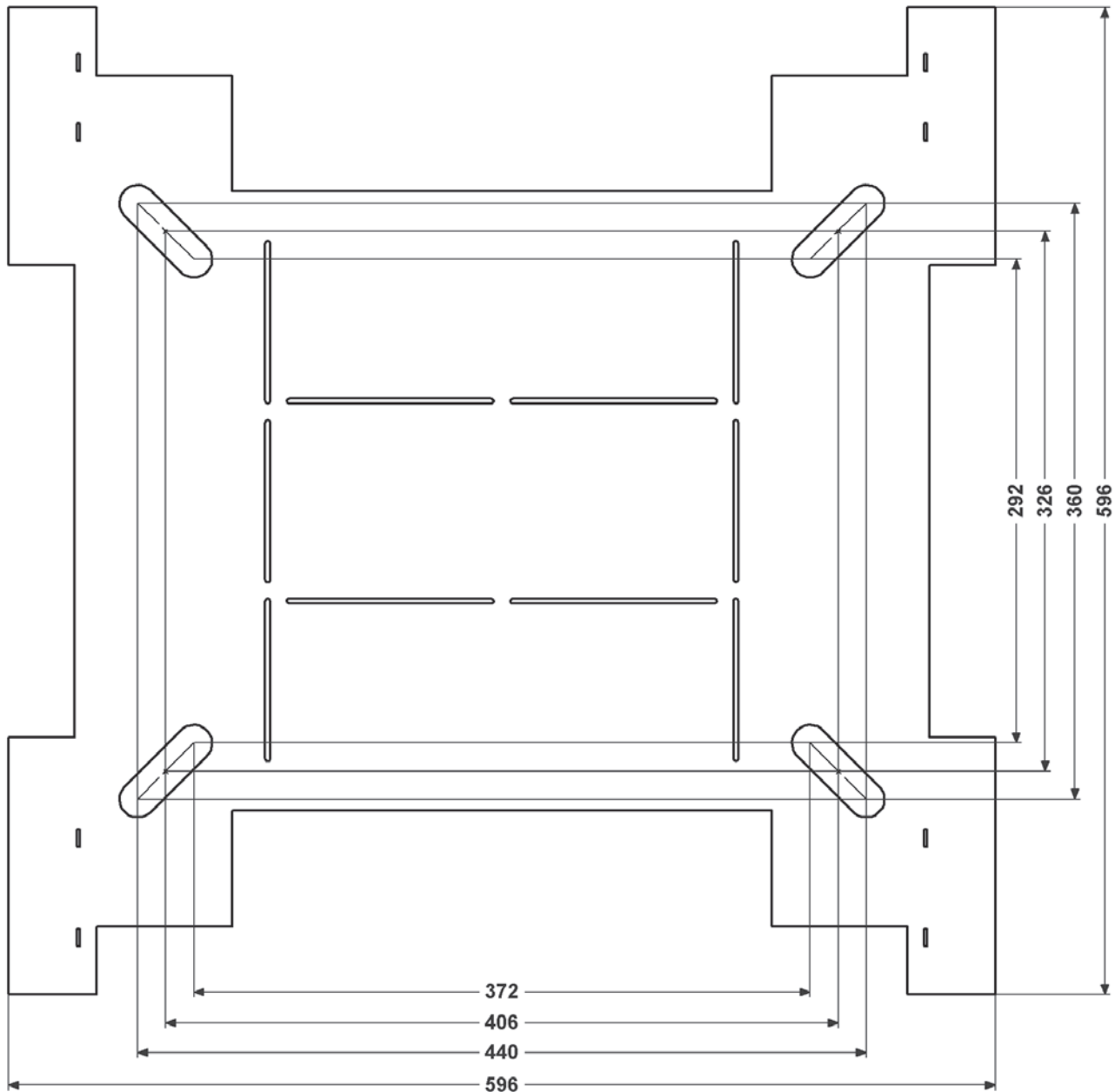

## 19.2 Single phase circuit diagram

